

IS-II active

Fantastic surface, Bioseal, and Perfect achievement of CMI fixation.



Osteoconductive S.L.A. Surface

No residual acid and cytotoxicity were observed in the surface examination.

IS-II active

Product Catalog



Contents

S.L.A. Surface of IS-II active	4
Features of IS-II active	6
IS-II active Line up	8
Prosthetic Flow Chart	10
IS Full Kit	12
IS Full Kit Components	13
IS-II active Drilling Sequence	15

S.L.A. Surface of IS-II active

|| S.L.A. (Sandblasting with Large grit and Acid etching)

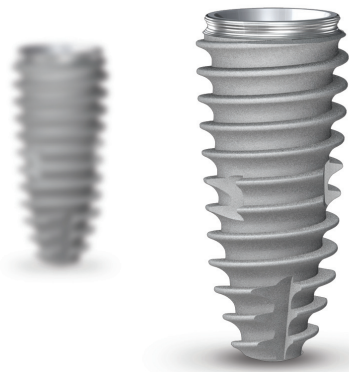

IS-II active Surface

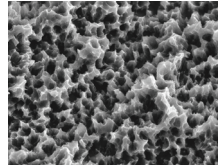

Macropore & Micropore

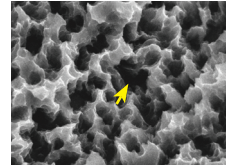

Macropores and micropores formed by S.L.A. surface treatment increase B.I.C.(Bone-Implant Contact) and allow better blood flow on the implant surface.

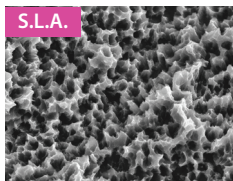

S.L.A. Surface

S.L.A. surface is formed by undergoing the process of sandblasting with smaller than 50 μ m HA (Hydroxy Apatite) particles to roughen the machined surface and to form many macropores. After sandblasting and acid etching is done to increase B.I.C. and promote cell's activity. With this process, the typical treatment period can be shortened and the patients will be more satisfied with the result.

|| S.L.A. Surface Treatment Process

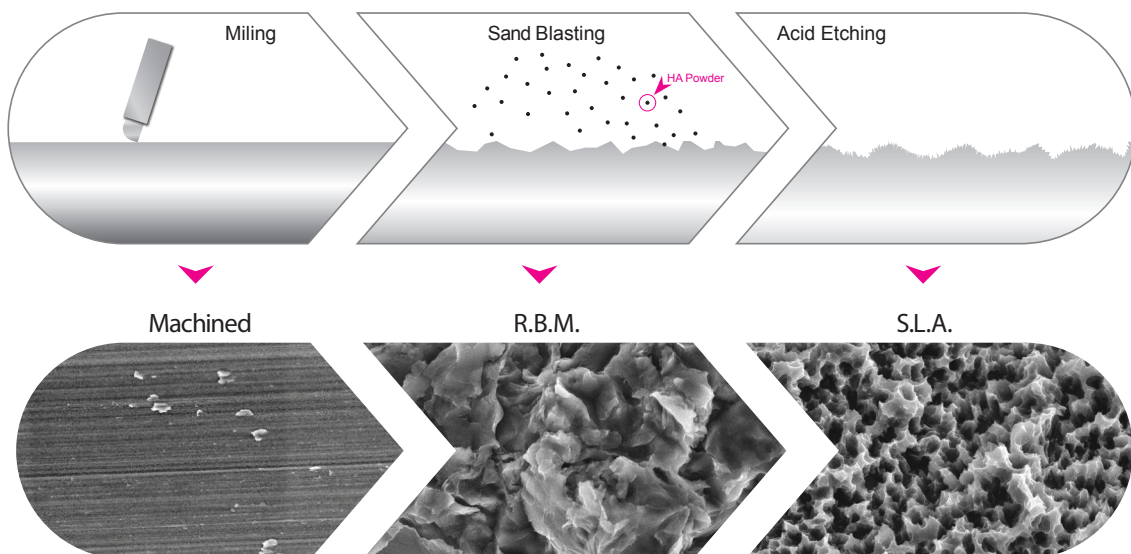

S.L.A. Surface of IS-II active

Roughness of IS-II active

Regular roughness / R.A. 2.0 (Roughness Average)

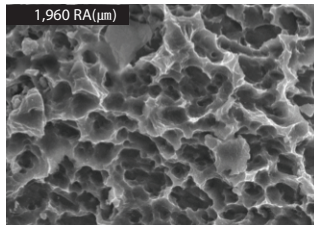

Other company's S.L.A. Surface

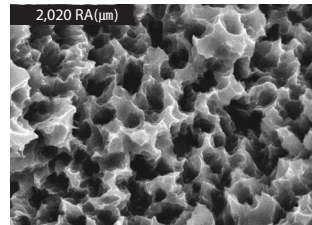

Neobiotech's S.L.A. Surface

Cell adhesion capability of S.L.A. Surface

It is observed that S.L.A. surface has the capability of attaching more cells on the titanium surface than the machined or R.B.M. surfaces.

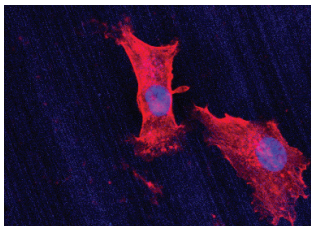

Machined

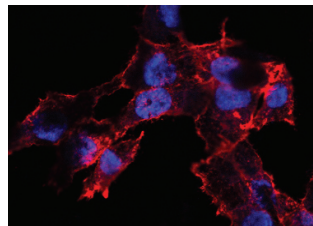

R.B.M.

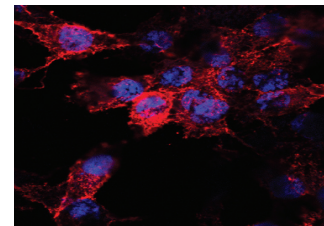

S.L.A.

Measured distance of newly formed bone

Measured distance of newly formed bone is approved to be longer in S.L.A. surface compared to R.B.M. surface.

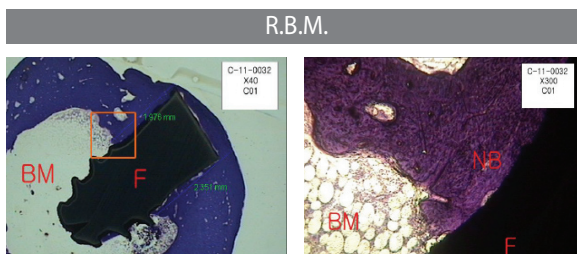

Distance of newly formed bone Left : 1.976mm/ Right : 2.35mm

F : Fixture / BM : Bone Marrow / NB : New Bone

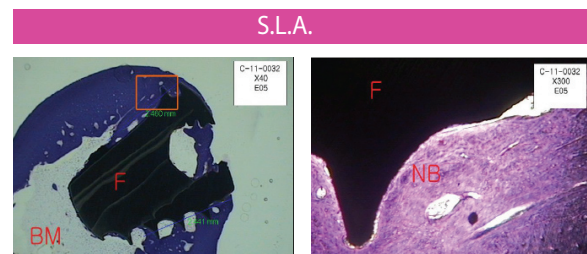

Distance of newly formed bone Left : 2.460mm Right : 2.41mm

F : Fixture / BM : Bone Marrow / NB : New Bone

Features of IS-II active

Based on the accumulated clinical cases and studies over 10 years, IS-II active has been continuously developed for the improvement. IS-II active has an internal submerged type design with S.L.A. surface that allows faster and stronger osseointegration.

BioSeal(0.5mm)

BioSeal is a curved S shape placed at the top of the fixture broadens the surface and increases the attachment of the soft tissue, therefore minimizes the bone loss.

Straight-Taper Body

helps implant to be drilled and inserted smoothly and also self-compaction is easily achieved in the soft bone.

Apex

Apex is powerful in drilling and due to this self-compactable and tapered apex design, initial fixation is easily achieved. It works great in both immediate placement and immediate loading.

Coronal Macro Thread

(Thread pitch 0.8mm)

Coronal Macro thread gains better primary stability at the cortical bone that helps to achieve better fixation in immediate placement.

Magic Thread

Magic Thread helps to achieve strong and stable initial fixation and also the inverted triangular threads enables to endure vertical and lateral forces.

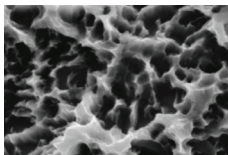
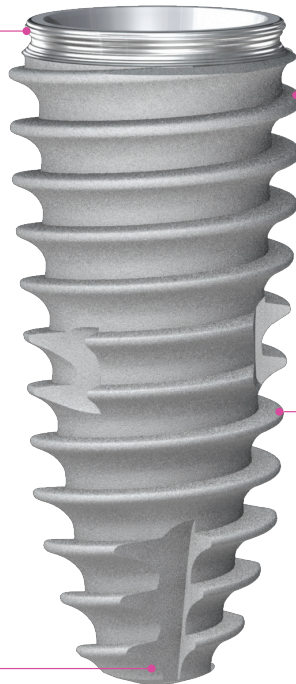

■ S.L.A. Surface

S.L.A. Surface has no impurities on the implant surface (No residual acid or cell toxicity is observed in the material examination). Also it has an appropriate rough average that can have the excellent osteoconductivity.

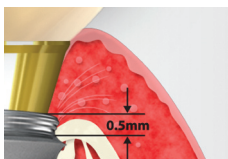

■ BioSeal

BioSeal has a curved S shape with the application of 0.5mm micro grooves on the machined surface. This design is invented to minimize the bone loss by maximizing soft tissue sealing.



■ Coronal Macro Thread

Coronal macro threads helps to achieve excellent primary stability at the cortical bone and initial fixation at the apex is excellent, therefore IS-II active works great in both immediate placement and immediate loading.

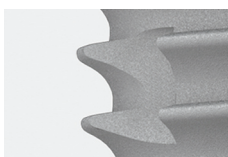

■ Magic Thread

Magic Thread with the inverted triangular shaped powerful deep thread helps to achieve strong and stable initial fixation and also this special design allows to endure vertical and lateral forces effectively.

Features of IS-II active

Connection of IS-II active

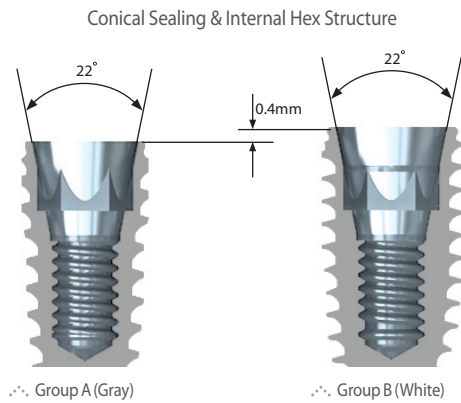

- Group A : IS-II active all Narrow,
Regular, Wide 7.3mm Fixture

- Group B : IS-II active Regular,
Wide 8.5, 10.0, 11.5, 13.0mm Fixture

IS-II active Fixture is compatible with all abutments of IS system.

* In order to increase the strength of fixture body, Internal hex of Group A is designed 0.4mm higher than Group B.

Fixture Placement Procedure



Take the fixture out from the box



Remove the package surrounding the fixture

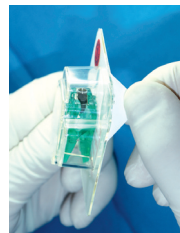

Take of the back seal



Take out the holder carefully



Connect the fixture to the driver



Take the fixture out from the holder



IS-II active Fixture Line Up

Narrow Ø 3.5

Actual Size

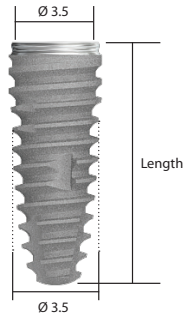

Length (mm)	Product Code
8.5	BIS3508A
10.0	BIS3510A
11.5	BIS3511A
13.0	BIS3513A

Regular Ø 4.0

Actual Size

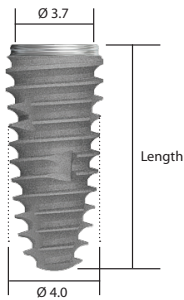

Length (mm)	Product Code
7.3	BIS4007A
8.5	BIS4008A
10.0	BIS4010A
11.5	BIS4011A
13.0	BIS4013A

Regular Ø 4.5

Actual Size

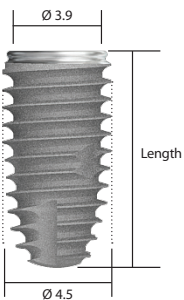

Length (mm)	Product Code
7.3	BIS4507A
8.5	BIS4508A
10.0	BIS4510A
11.5	BIS4511A
13.0	BIS4513A

Wide Ø 5.0

Actual Size

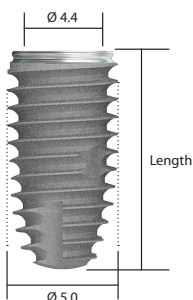

Length (mm)	Product Code
7.3	BIS5007A
8.5	BIS5008A
10.0	BIS5010A
11.5	BIS5011A
13.0	BIS5013A

IS-II active Fixture Line Up

S-wide

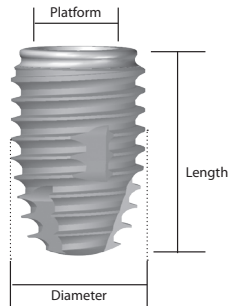

Diameter (Ø)	Platform (Ø)	Length (mm)	Code
5.5	4.4	7.3	BIS5507A
		8.5	BIS5508A
		10.0	BIS5510A
		11.5	BIS5511A
		13.0	BIS5513A
6.0	4.9	7.3	BIS6007A*
		8.5	BIS6008A*
		10.0	BIS6010A*
		11.5	BIS6011A*
		13.0	BIS6013A*
7.0	5.8	7.3	BIS7007A*
		8.5	BIS7008A*
		10.0	BIS7010A*
		11.5	BIS7011A*
		13.0	BIS7013A*

Short

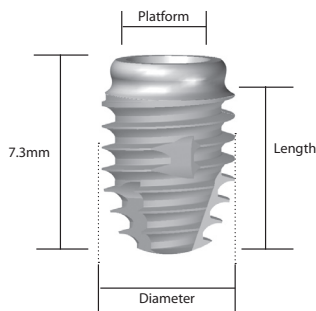

Diameter (Ø)	Platform (Ø)	Length (mm)	Product Code
5.0	4.4	5.0	BIS5005A
		6.0	BIS5006A
5.5	4.5	5.0	BIS5505A*
		6.0	BIS5506A*

S-wide Kit



* S-Wide Kit is necessary to place S-wide Fixture and Ø 5.5 Short Fixture

Prosthetic Flow Chart

Solid Abutment

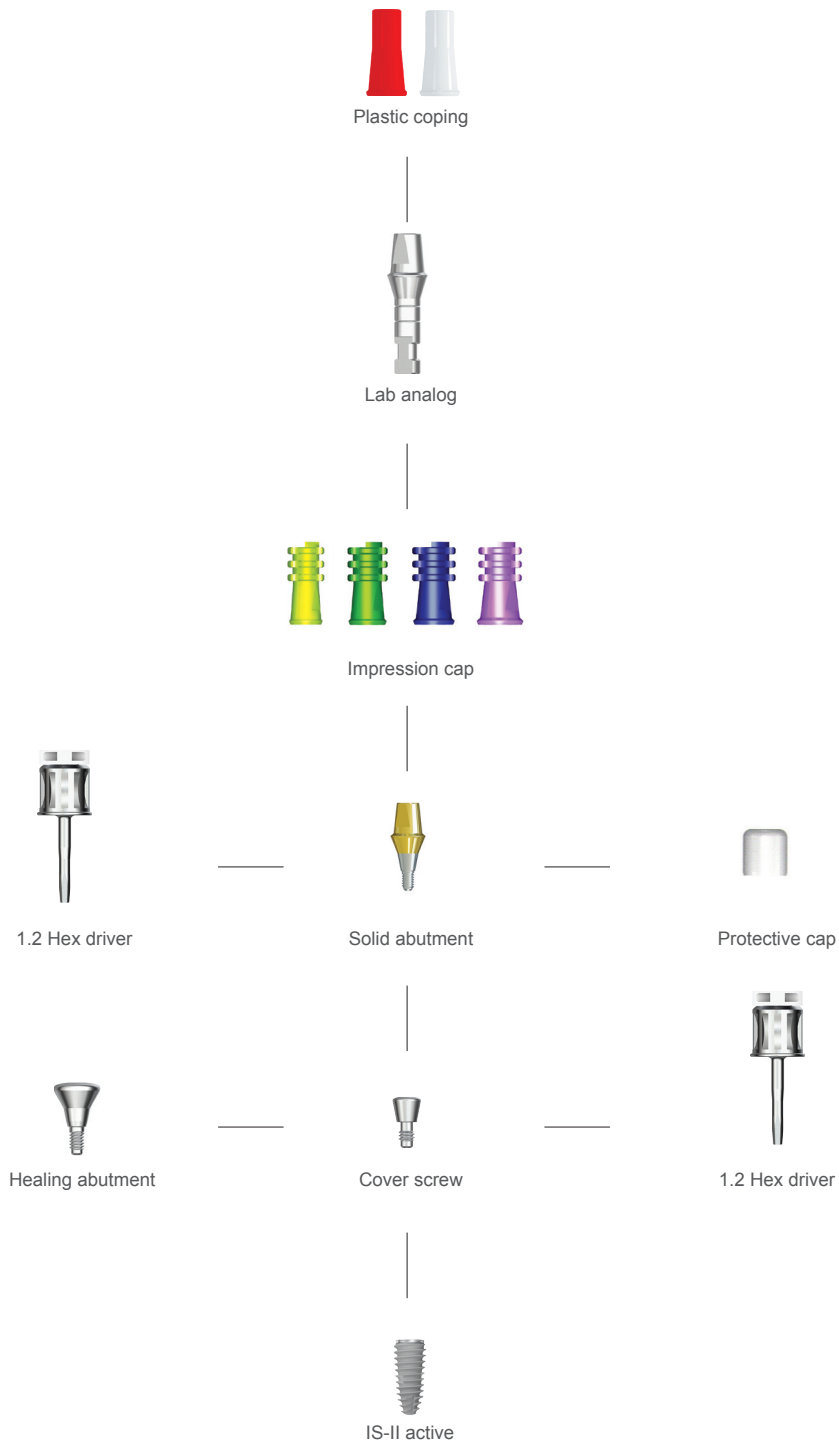

Prosthetic Flow Chart

Cement & Screw Abutment

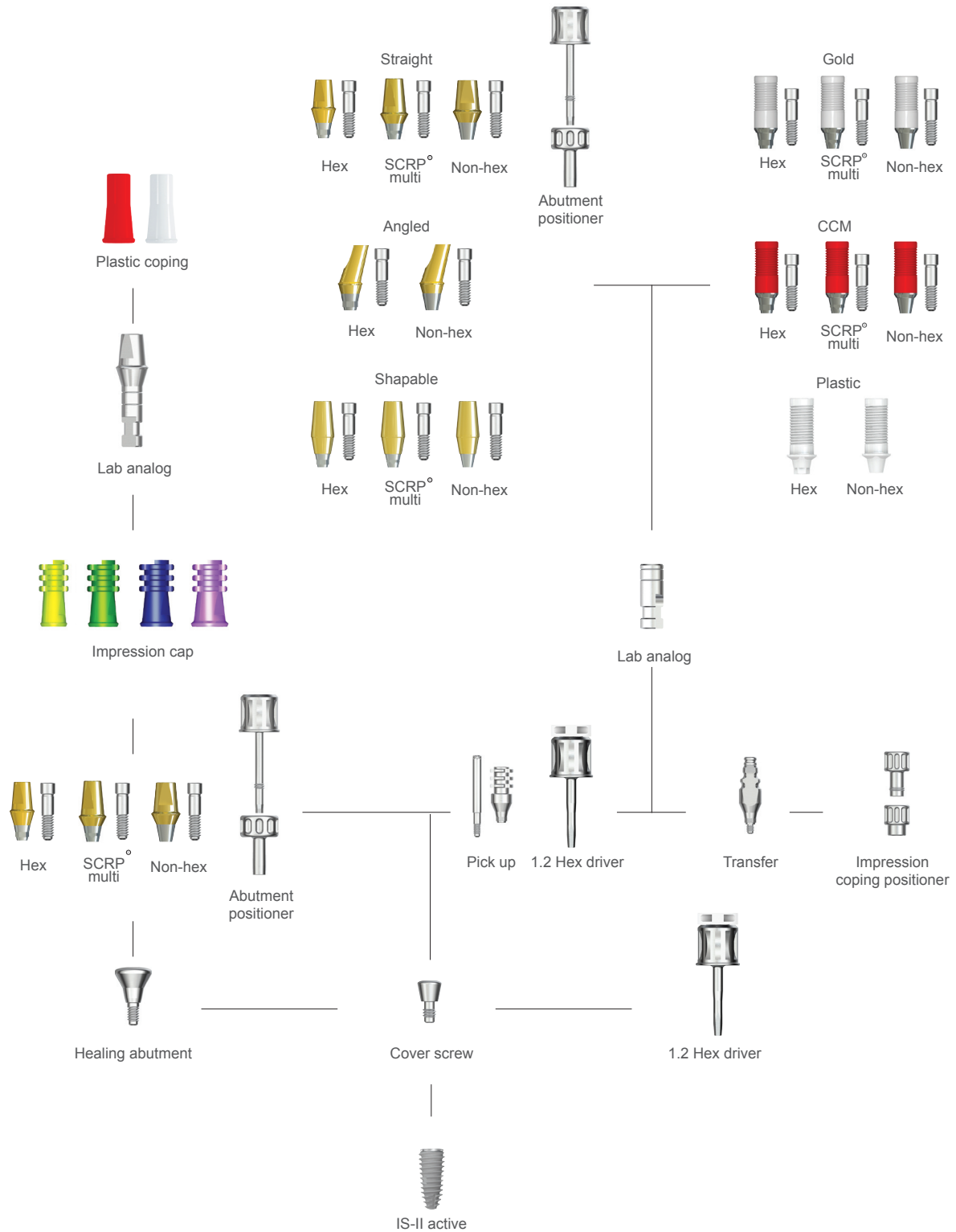

IS Full Kit

This kit can be used to perform implant surgery for IS-II active, IS-II and IS (Ø3.5 ~ 5.5).
For S-wide (Ø6.0 ~ 7.0) implant surgery, S-wide kit is additionally required.

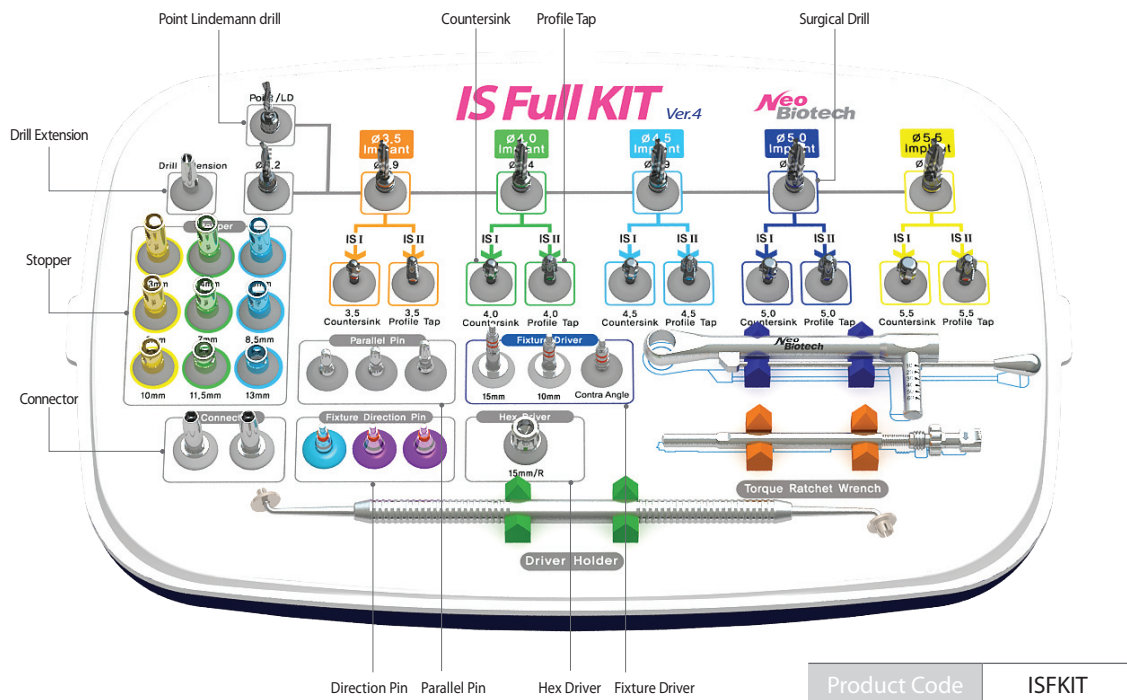

IS Full Kit User Manual

1. Follow the guidelines marked in different colors on the kit tray when placing the fixture. Drill sequentially in order to place the implant properly.

Ex) When placing Ø4.5 Implant

Ø2.3/LD Drill >> Ø2.2 Drill >> Ø2.9 Drill >> Ø3.4 Drill >> Ø3.9 Drill

2. Counter sinking for IS or profile tapping for IS-II Fixture in the D1 / D2 dense bone is recommended selectively but the operator may skip the procedure when it is determined not necessary.

Ex) When placing IS Ø4.5 Implant

Ø2.3/LD Drill >> Ø2.2 Drill >> Ø2.9 Drill >> Ø3.4 Drill >> Ø3.9 Drill >> Ø4.5 Counter Sink

IS Full kit is used for placing IS, IS-II and IS-II active fixtures.









*S-wide kit is necessary when placing IS S-wide or IS-II S-wide fixtures.











Neo CMI Implant

IS Full Kit Components





Surgical Drill

	Diameter	Code
	Point Lindemann	LDS23
	Initial Drill Ø2.2	TSD22F
	Twist Drill Ø2.9	TSD29F
	Twist Drill Ø3.4	TSD34F
	Twist Drill Ø3.9	TSD39F
	Twist Drill Ø4.4	TSD44F
	Twist Drill Ø4.9	TSD49F





Stopper

	Length	Code
	3.0 mm	DS030F
	4.0 mm	DS040F
	5.0 mm	DS050F
	6.0 mm	DS060F
	7.0 mm	DS070F
	8.5 mm	DS085F
	10.0 mm	DS100F
	11.5 mm	DS115F
	13.0 mm	DS130F



Counter sink

	Diameter	Code
	Ø3.5	ISCS35F
	Ø4.0	ISCS40F
	Ø4.5	ISCS45F
	Ø5.0	ISCS50F
	Ø5.5	ISCS55F



Profile Tap

	Diameter	Code
	Ø3.5	PTAP35F
	Ø4.0	PTAP40F
	Ø4.5	PTAP45F
	Ø5.0	PTAP50F
	Ø5.5	PTAP55F



Direction Pin

	Diameter	Code
	Ø5.0	DPI50
	Ø6.0	DPI60



Ratchet Connector

	Type	Code
	Short (10mm)	RC10
	Long (15mm)	RC15

IS Fixture Driver

	Type	Code
	Contra Angle	ISFD05C
	Ratchet (Short)	ISFD10R
	Ratchet (Long)	ISFD15R

Parallel Pin

	Length	Code
	7.0 mm	PP07F
	8.5 mm	PP08F
	10.0 mm	PP10F

Hex Driver

	Code
	HD1215

Drill Extension

	Code
	DE01

Torque Ratchet

	Code
	TW60

Depth Gauge

	Code
	MG00

Driver Holder

	Code
	DH01

IS Full Kit Components

Surgical Drill

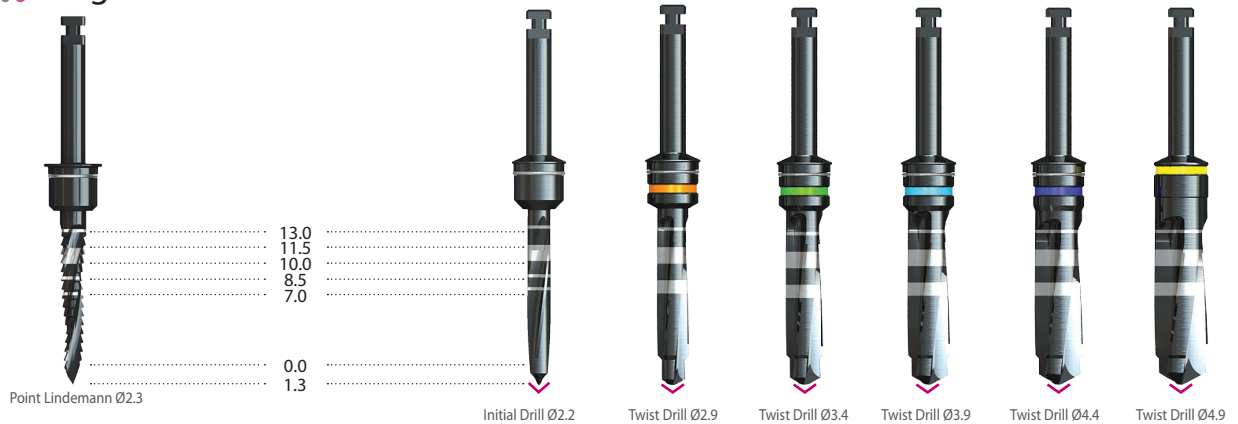

>> * Function of Point Lindemann Drill

1. Point Drilling - Marking drilling position (Drill 4~5mm)
2. Cutting Side – Controlling path while drilling the extraction site

All drills are coated with black color in order to make operator easy when checking the drilling depth.

Twist drills have specially designed round tip.

* The actual drilling depth of Point Lindemann Drill and Ø 2.2 Initial Drill are 1.3mm longer than the marked length.

Stopper

Stopper Length	3.0mm	4.0mm	5.0mm	6.0mm	7.0mm	8.5mm	10.0mm	11.5mm	13.0mm
Drilling Length	3.0mm	4.0mm	5.0mm	6.0mm	8.1mm	9.3mm	10.8mm	12.3mm	13.8mm

Drilling Length

The actual length of drill is longer than the indicated length.

(Tip length of Lindermann, Initial drill : 1.3mm, Ø2.9 drill : 1.0mm, Ø3.4~Ø4.9 : 0.8mm)

Countersink

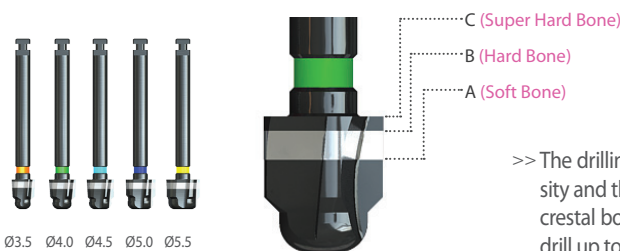

Countersink is usually used for IS fixtures when the cortical bone density is high, however it also can be used for IS-II in some clinical cases when it is necessary.

>> The drilling depth for the countersink drill depends on the patient's bone density and the line A B C are divided according to the bone density. If the patient's crestal bone is super hard with high density, drill up to C, for hard crestal bone drill up to B and lastly, for the soft bone drill only up to A line.

Profile Tap

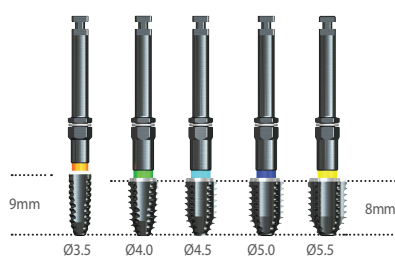

>> Profile tap is usually used for IS-II and IS-II active fixtures and it helps to achieve initial stability and to be inserted smoothly since the thick and hard cortical bone is pre tapped.

>> Used with contra angle and with four blades, tapping is done easily

Pretap the cortical bone located around the top of the fixture, drill up to the marked line on the profile tap drill.

Profile Tap : 50 R.P.M / 50Ncm

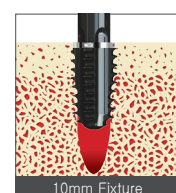

IS-II active Drilling Sequence

IS-II active Fixture $\varnothing 3.5$ X 10mm (D1/D2 bone)

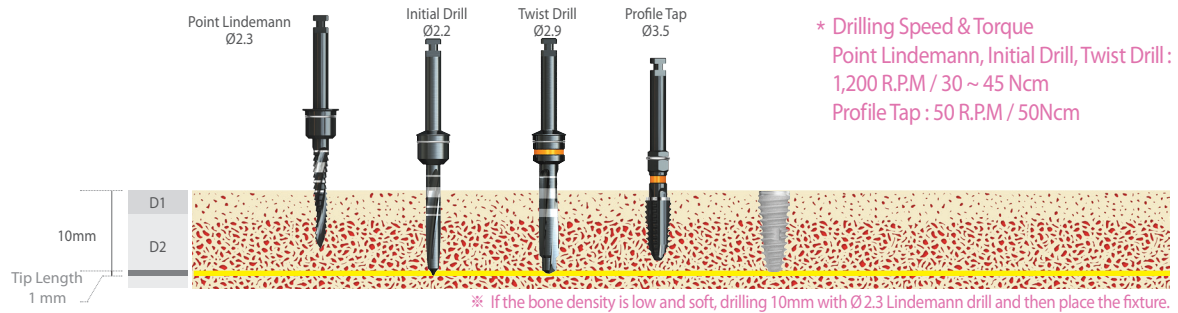

IS-II active Fixture $\varnothing 4.0$ X 10mm (D1/D2 bone)

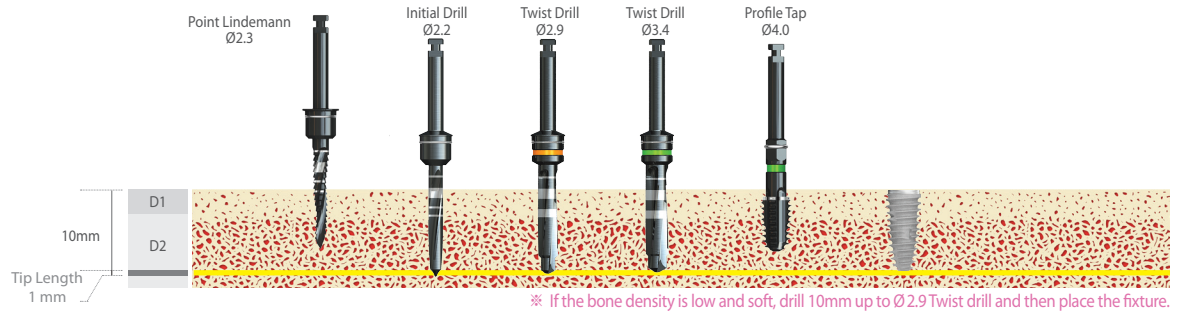

IS-II active Fixture $\varnothing 4.5$ X 10mm (D1/D2 bone)

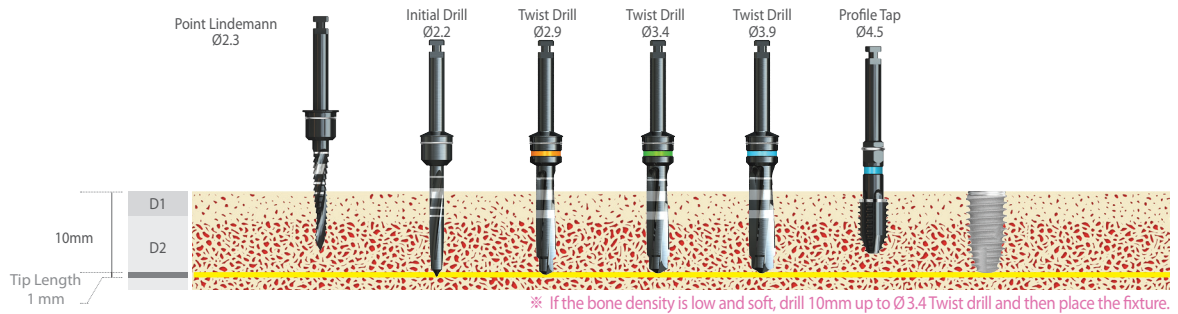

IS-II active Fixture $\varnothing 5.0$ X 10mm (D1/D2 bone)

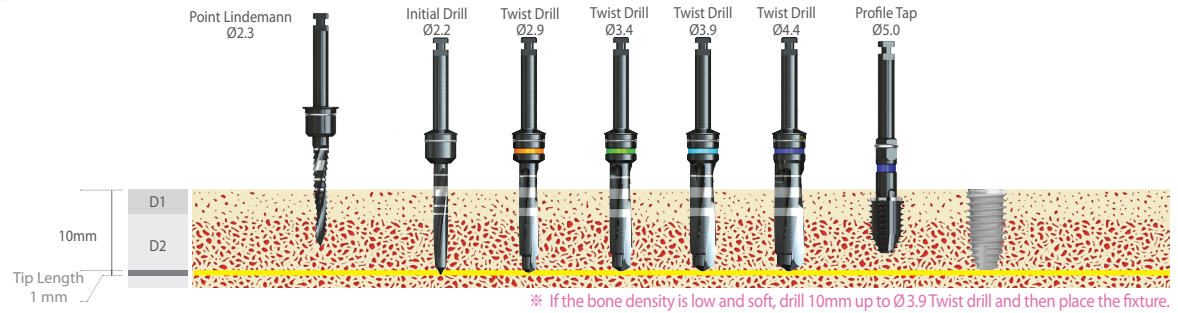

IS-II active Fixture $\varnothing 5.5$ X 10mm (D1/D2 bone)

